

# Data Sheet



Article number: 021816025172

Description: Clamp with bracket and rubber  
SPGU 6025. 172/30 SK

## Measures

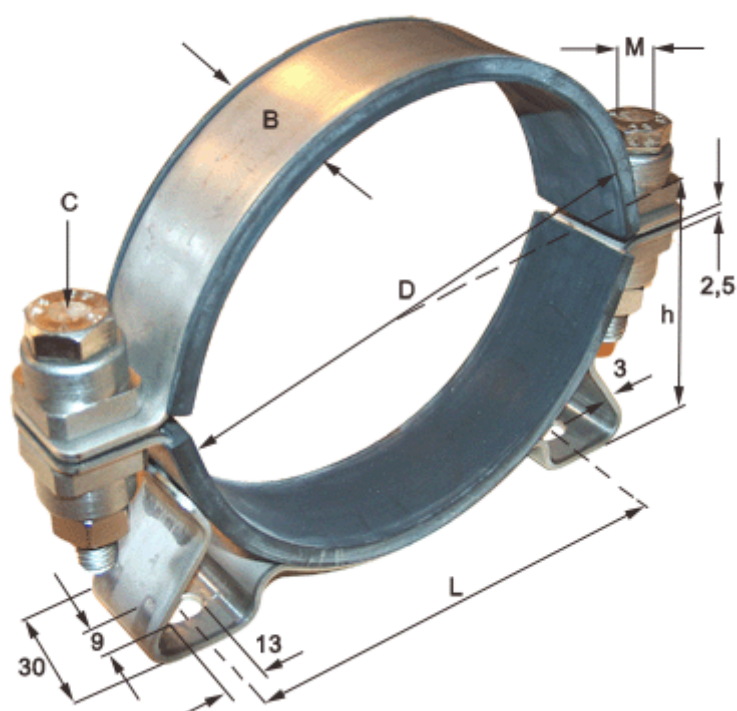

C (screw type) = SK hexagon screw

Diameter D = 172

h = 95

L = 148

Width B = 30